

Fusion5S[™]

3G - 4G Home Five-Band Signal Booster Kit

User Guide



INTRODUCTION

Thank you for purchasing SureCall's Fusion5s cellular signal booster kit. Fusion5s was specifically designed to eliminate frustrations over dropped calls, limited range and slow data rates by amplifying incoming and outgoing cellular signals in homes up to 6,000 square feet.

The Fusion5s provides enhanced cellular signals for multi-carrier 2G, 3G and 4G voice and data reception. If you have any questions while assembling this kit please contact tech support at 1-888-365-6283 or email us at: support@surecall.com.

TABLE OF CONTENTS

INTRODUCTION2
HOW IT WORKS3
PACKAGE CONTENTS.....4
Installation Overview6
Step 1. Find the area with the Strongest Signal7
Step 2. Install the Outside Antenna8
Step 3. Install the Inside Antenna10
Step 4. Install the Signal Booster12
Booster Hardware12
If you Want to Improve Coverage12
LED INDICATORS13
LED Information13
TROUBLESHOOTING13
SPECIFICATIONS14
3-YEAR PRODUCT WARRANTY15
USER CAUTION16

HOW IT WORKS

SureCall's Fusion5s is a high-quality bidirectional signal booster that enhances cellular signals to areas that are prone to weak cellular coverage.

Fusion5s works with two antennas:

- An inside antenna that communicates with your cell phone.
• An outside antenna that communicates with the cell tower.

Signals sent from a cell tower are received by the outside antenna, amplified by the booster and then sent to your phone via the inside antenna. When your phone transmits, the signal is sent to the inside antenna, and then sent to the cell tower via the outside antenna.

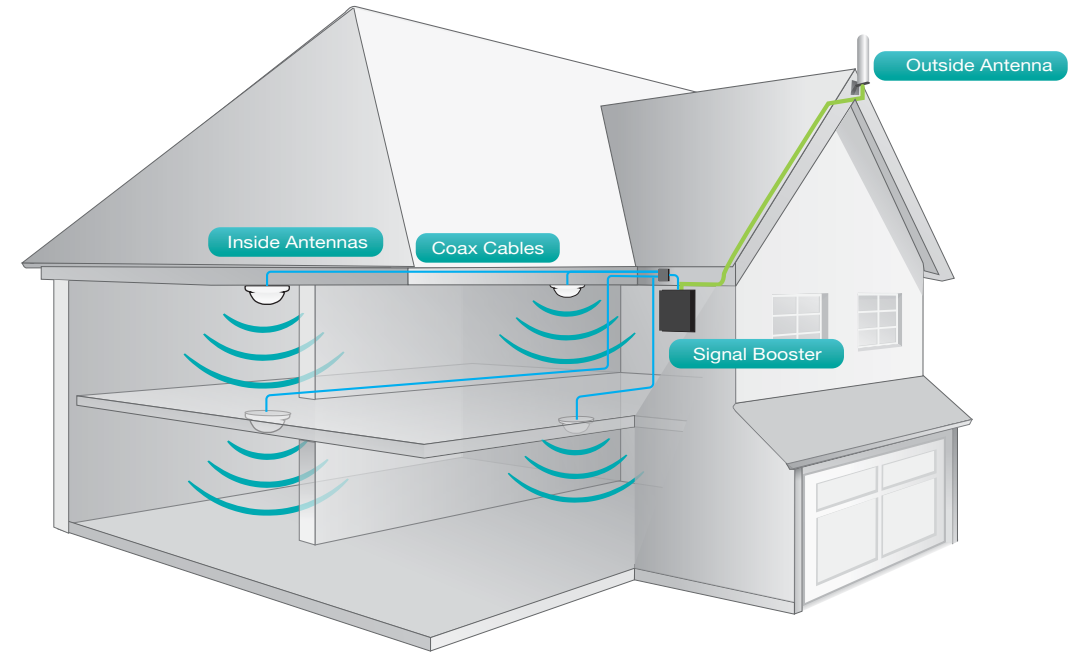

PACKAGE CONTENTS

1. Unpack all package contents. For missing or damaged items, contact your reseller.
2. Turn over the signal booster and record the model and serial number for reference:

Serial #: _____

Purchase Date: _____

3. Keep the carton and packing material to store the product in case you need to return it.

Standard Fusion5s signal booster packages include the following items:

- One SureCall Fusion5s booster and power supply
- One outside antenna
- Cable for connecting the outside antenna to the signal booster
- One inside antenna
- Cable for connecting the inside antenna to the signal booster

Booster

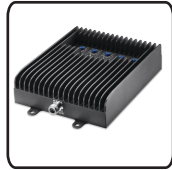

Fusion5S

Outside Cable



75 ft cable-SC-400

Inside Cable (options)

Single Antenna Kits



100 ft cable-SC-400

Multiple Antenna Kits



Splitter + 30 ft SC400



75 ft cable-SC-400

Outside Antenna (options)



Omni



Yagi

Inside Antenna (options)







Dome(s)



Panel(s)

Note: Fusion5s is available in four kits that are customized to your particular needs. Please determine which kit you have from the following list:

Model	Package Options
SC-PolysH/O-72-OD-Kit	1 Outdoor Omni antenna, 1 interior dome antenna, 30' and 75' SC-400 coax cables
SC-PolysH/O-72-YD-Kit	1 Outdoor Yagi antenna, 1 interior dome antenna, 30' and 75' SC-400 coax cables
SC-PolysH/O-72-OP-Kit	1 Outdoor Omni antenna with 1 interior panel antenna, 30' and 75' SC-400 coax cables
SC-PolysH/O-72-YP-Kit	1 Outdoor Yagi antenna with 1 interior panel antenna, 30' and 75' SC-400 coax cables

	Antenna Type	Model No.	Usage Coverage
	Omni Outdoor Antenna	SC-288W	Omni antennas are ideal for topographies with minimal obstacles, they have 360° reception
	Yagi Outdoor Antenna	SC-230W	Yagi antennas are designed to reach carrier towers that are up to 30 miles away
	Dome Antenna	SC-222W	Dome antennas are designed for central locations with 360° coverage
	Panel Antenna	SC-248W	Panel Antennas allow optimum reception to targeted areas

Warning: Unauthorized antennas, cables, and/or coupling devices are prohibited by FCC rules. Please contact the FCC for details: 1-888-CALL- FCC. Changes or modifications not expressly approved by SureCall could void the user's authority to operate the equipment.

Before beginning installation, please note:

- Make sure you have positioned the booster close enough to an existing electrical outlet.
- Make sure you have sufficient cable length between proposed outside antenna location and booster connector.
- Make sure you have sufficient cable length between proposed inside antenna location and booster connector. Additional cable may be purchased from your dealer, if needed.

Installation Overview

Step 1. Find the outside area that has the strongest signal.

Step 2. Install the outside antenna in the area identified in step 1.

Step 3. Install the inside antenna.

Step 4. Mount the signal booster, connect the outside and inside antenna cables to the signal booster, and connect the booster to an AC power source.

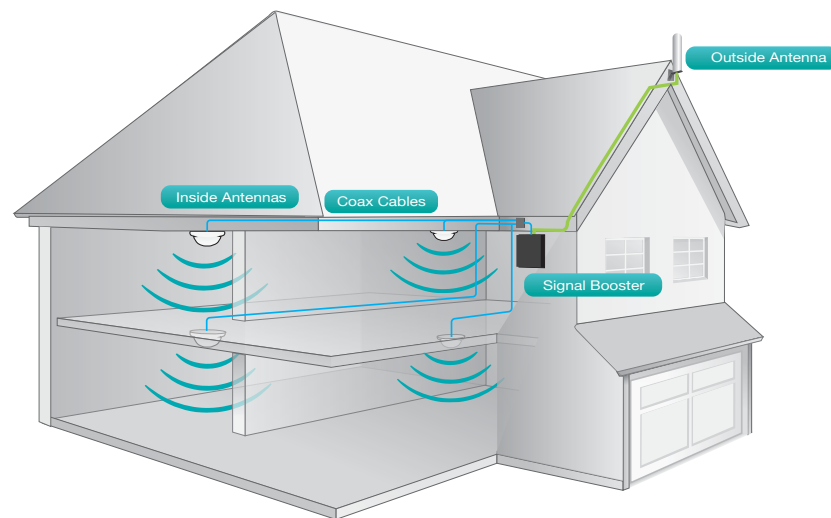

Step 1. Find the area with the Strongest Signal

The signal booster requires a minimum cellular signal of low -100 dBm. Signal readings usually appear as a negative number (for example, -85). The more bars you get, the closer the dB gets to zero. Aim for a signal close to -70 dB. Signals stronger than -50 dB may cause the booster to shut down (see the graph below). If you have an omni outside antenna and your signal is too weak you may need a yagi antenna, which can be aimed at the closest antenna tower. Before installing the outside antenna, find the strongest cellular signal source from your service provider by following the directions below. You can also go to www.antennasearch.com to find the general location of carrier towers.

Measure the strength of the existing cellular signal in various locations.

- Apple iPhones: Dial *3001#12345#* and press Call. In the top-left corner, a dB number appears instead of bars.
- Android devices: download apps such as “Network Signal Info” in the Google Play store to measure signal strength. Search check real signal strength to find other cell signal measurement apps.
- Internet: go to www.speedtest.net to test 3G and 4G data rates.

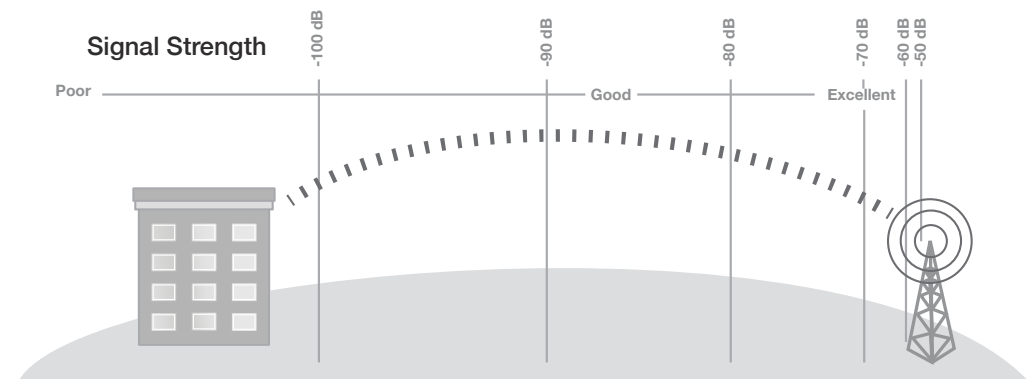

Select a location away from buildings, walls, trees, hills, and other terrain features that can block or reflect wireless signals (12-inch clear radius is recommended).

Note: Where you install your outside antenna in relation to the carrier's cell phone tower also determines signal strength. Although cell phone carriers try to place towers for maximum coverage, local ordinances and terrain features can restrict tower locations, which can limit signal strength at your location.

Step 2. Install the Outside Antenna

1. Outside omni antennas receive and send signals in a 360° radius. Yagi, or directional antennas work best when facing the direction of cellular phone towers. Mount the outside antenna as high as possible. If you are installing a Yagi antenna set it up facing the cellular tower in the area where you located the best signal source (see step 1 on the previous page).
2. Make sure that the mounting area has at least a 12-inch radius clear of obstructions and other radiating elements.
3. If the mounting area is prone to weak cellular signals or if the density of the roof and ceiling partially block the signal, the booster will operate at its default setting of 65 dB gain, be sure to place the outside antenna at least 75 feet from the inside antenna for best performance.
4. Do not collocate antennas or operate the outside antenna with any other antenna or signal booster.
5. Run the SC-400 cable from the outside antenna to the signal booster. Hand tighten the connection

FCC 27.5 (d)(4) Statement: Fixed, mobile, and portable (hand-held) stations operating in the 1710-1755 MHz band as well as mobile and portable stations operating in the 1695-1710 MHz and 1755-1780 MHz bands are limited to 1 watt EIRP. Fixed stations operating in the 1710-1755 MHz band are limited to a maximum antenna height of 10 meters above ground. Mobile and portable stations operating in these bands must employ a means for limiting power to the minimum necessary for successful communications.

Fusion5s' omni antennas come with equipment for mounting on a vertical wall. For best results the antenna should be mounted in an upright position.

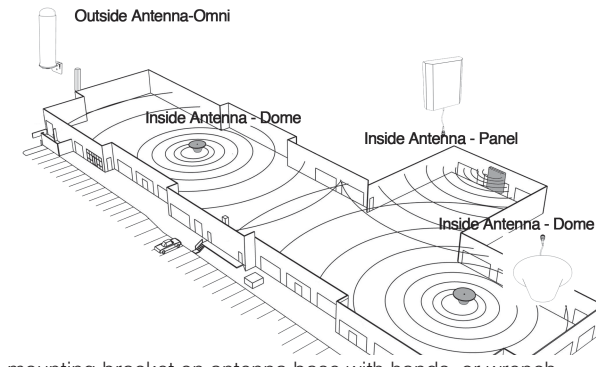

Step 1: Unscrew antenna from L-mounting bracket on antenna base with hands, or wrench, if needed.

Step 2: Using vertical plate of bracket, mark position of desired placement with pencil or marker.

Step 3: Unscrew nut on end of stucco screw and remove it along with lock washer and regular washer.

Step 4: Place vertical plate into desired location and tap the screws head first, along with sleeve, into stucco 1/2" to 5/8" deep into place.

Step 5: In this order, place washer, lock washer and nut on each screw and tighten until secure. When tightening screw, sleeve will expand to secure plate. Screw antenna securely back onto horizontal plate.

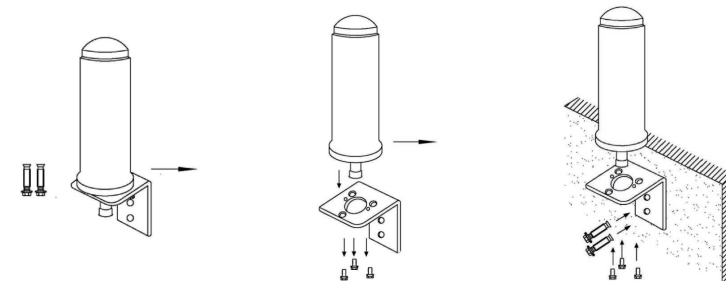

Note: If desired surface for installation plate is wood or concrete, wood or masonry screws for L-plate will have to be purchased separately.

Step 3. Install the Inside Antenna

Inside antennas come in omni-directional (dome) and flat panel versions.

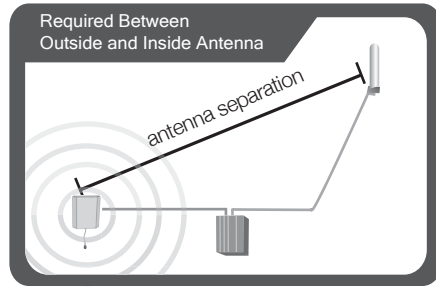

Antenna Separation Table

Amplifier gain	Min. separation (ad)
40dB	5-6'
45dB	15-20'
50dB	50'
55dB	60'
65dB	75-80'
72dB	100'-110'

Note: As you can see from the table above, acquiring the recommended inside and outside antenna separation optimizes coverage significantly. Any reduced antenna separation reduces the booster's coverage.

1. If your indoor antenna is a dome type, mount it on the ceiling in a central location.
2. If your indoor antenna is a flat panel, install it against a wall or surface projecting the area where you want reception. Point the antenna away from the outside antenna. To avoid interference stay a minimum distance of 3 feet from the panel antenna.
3. Run the SC-400 cable from the inside antenna to the signal booster. Connect the inside antenna to the booster connector marked INSIDE.
4. Hand tighten the connection.

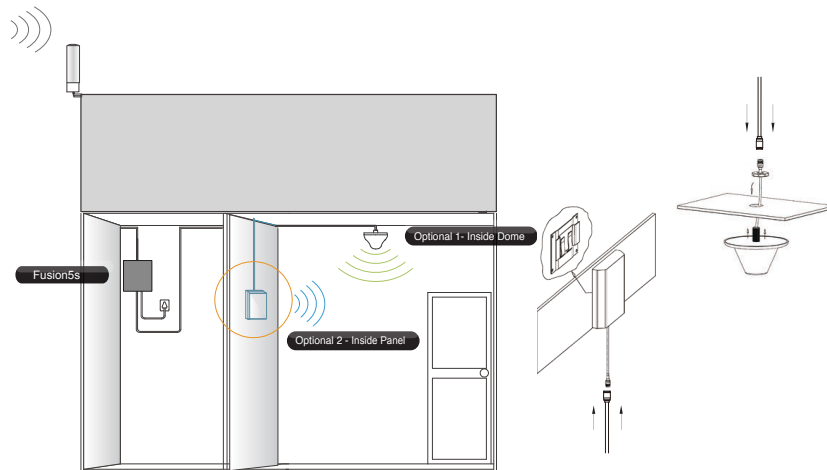

Note: see next page for outside antenna installation details.

The SC-222W multi-band plastic antenna is an omni-directional interior antenna that gathers signals from all sides. Range of antenna is dependent on three factors:

1) physical obstructions, 2) power generated by booster and 3) reception from outside signal received and distributed by outside antenna.

Besides the antenna itself, parts include mounting equipment for either a flat horizontal surface or a wall. It should be mounted in an upright position for best results. You can also install your interior antenna above the ceiling panel provided your ceiling isn't made of a material that could obstruct signals from the booster.

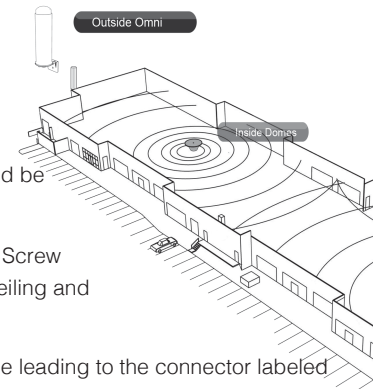

Step 1: Drill a 20mm diameter hole in the ceiling. The ceiling thickness should be 20mm, maximum.

Step 2: Unscrew fixing nut from antenna. Place antenna cable through hole. Screw the fixing nut back onto antenna and cable on crawl space side of ceiling and fasten.

Step 3: Attach the N-Female connection from the interior antenna to the cable leading to the connector labeled INSIDE, on your booster.

Step 4: Tighten fixing nut to secure antenna (do not over-tighten).

- Storage and transportation: Store and place in non-extreme room-temperature and dry environment
- Attention: This antenna should not be used near open fire or flame

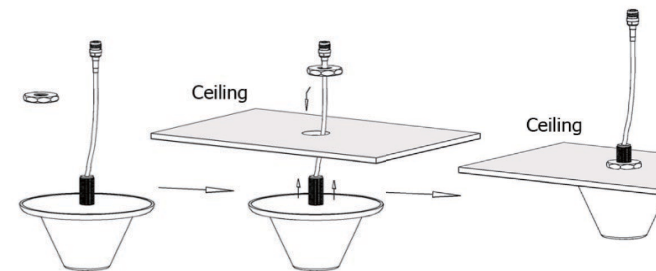

Step 4. Install the Signal Booster

1. Select a location close to a working AC outlet. Do not expose the signal booster to excessive heat, direct sunlight, moisture, and airtight enclosures. If you'd like to mount the booster to a wall, mark location of screw tabs on the wall in the desired location.
2. Use supplied or appropriate screws for surface of mounting location and drill through screw tab holes on booster.
3. Connect the outside antenna cable to the signal booster connector marked OUTSIDE and tighten the connection.
4. Connect the inside antenna cable to the signal booster connector marked INSIDE and tighten the connection.
5. Connect the AC power cord to the signal booster.
6. Connect the plug on the other end of the 110V AC power outlet.
7. Turn the booster's power switch on.

Booster Hardware

The following image shows the key hardware components on the cellular booster. Refer to this image as you install your Fusion5s kit components.

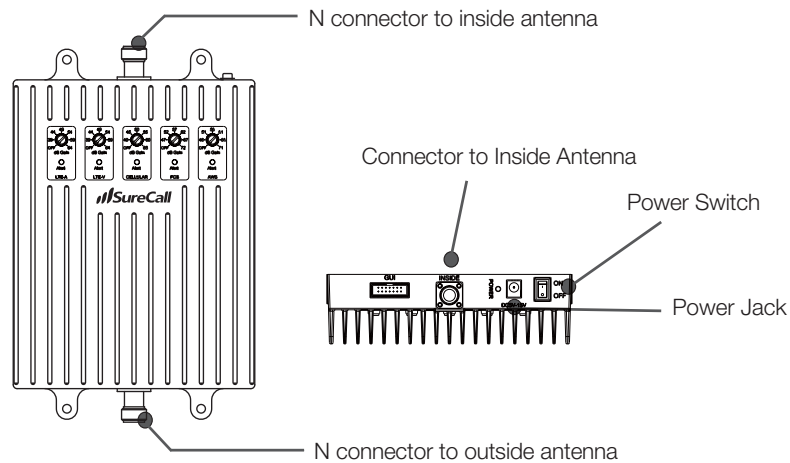

Note: If the Power LED does not turn ON or the Alert LEDs continue to flash, see PAGES 13.
This booster is rated for 5-20V input voltage. DO NOT use the booster with a higher voltage power supply. This can damage the booster, cause personal injury, and void your warranty

If you Want to Improve Coverage

1. Find a location that receives a stronger signal and relocate the outside antenna to that location.
2. Increase the distance between the outside and inside antennas.
3. Be sure your signal booster's dB gain is turned up to maximum gain on each dial.

Remember, Bars are not always a reliable measure of signal. The best way to confirm signal coverage is the ability to place and hold a call.

LED INDICATORS

Please note the following information:

- Only the presence of RED or RED-YELLOW LEDs indicate the presence of an unresolved issue.
- Your booster switches should always be at maximum level unless the control light for a specific frequency band is flashing RED or RED-YELLOW. In either case, only reduce gain if other recommended actions do not resolve the issue.

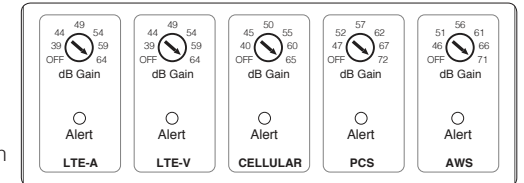

LED Information

Color	LED	Resolution
Green	Solid	Indicates that the frequency band is in use. This is part of normal operation.
Green	Flashing	Indicates that the booster is functioning properly by using Automatic Gain Control (AGC) technology to stabilize the signal entering your booster from the outside antenna. This is part of normal operation.
Yellow / Red	Alternately Flashing	Indicates that the booster is receiving too much signal which could cause the affected band to automatically turn off. When this happens: <ul style="list-style-type: none"> • For kits using an OMNI outside antenna, relocate the outside antenna to a location where the signal is weaker. • For kits using a YAGI outside antenna, turn the antenna in short increments away from the signal source. • Add an inline attenuator to the cable coming into the outside port of the booster. • Though not desirable as amplification will not be optimum, lower the dB gain setting in small increments until the light turns green.
Red	Flashing	The frequency band is off due to overpower. This can happen when the gain has been turned too low. To resolve, see the above suggestions.

TROUBLESHOOTING

Problem	Resolution
Signal booster has no power	Verify that the booster switch is turned on. Be sure the power source is not controlled by a switch that can remove power from the outlet by connecting to an alternate power source. If the POWER LED on the signal booster remains OFF, contact tech support at: 1-888-365-6283 or support@surecall.com
After installing your booster system, coverage has not improved.	Verify that cable connections are tightly fitted to the booster and antennas. Check the installation of your outdoor antenna. Ensure that the mounting area is clear of obstructions and other radiating elements. For kits that use a directional Yagi antenna, verify that the antenna is properly aimed in the direction of your carrier's closest cell tower. Check the outdoor signal strength at the site the outdoor antenna. If signal level is low, your resulting coverage will be limited. Remember that Bars are not always a reliable measure of signal. The best way to confirm signal coverage is the ability to place and hold a call.

SPECIFICATIONS

Product Name	Fusion5s / Fusion5s 2.0
Uplink Frequency Range (MHz):	698-716 / 776 – 787 / 824-849 1850-1915 / 1710-1755 (G Block Included)
Downlink Frequency Range (MHz):	728-746 / 746 – 757 / 869-894 1930-1995 / 2110-2155 (G Block Included)
Input and Output Impedance:	50 Ω
Maximum Gain:	72dB
Noise Figure:	8 dB
Supported Standards:	CDMA, WCDMA, GSM, EDGE, HSPA+, EVDO, LTE and all cellular standards
AC Input:	Input AC110V, 60 Hz; Output DC 12V
Maximum Output Power:	1 Watt EIRP
Cable:	SC-400
RF Connectors:	N Female (both ends)
Power Consumption:	<25W
Operation Temperature:	-4°F to +158°F
Dimensions:	9-1/4" x 6-3/8" x 1-3/8"
Weight:	3 LB
FCC (USA):	RSNEZBOOST5 / RSNFUSION5S-X20
IC	7784A-FUSION5S / 7784A-FUSIONX

3-YEAR PRODUCT WARRANTY

Register at www.SureCall.com

SureCall warrants its products for three years from the date of purchase against defects in workmanship and/or materials. Specifications are subject to change. The three-year warranty only applies to products meeting the latest FCC Certification Guidelines stated on 2/20/2013 and going into effect April 30, 2014. A two-year warranty applies to any products manufactured before May 1, 2014.

Products returned by customers must be in their original, un-modified condition, shipped in the original or protective packaging with proof-of-purchase documentation enclosed, and a Return Merchandise Authorization (RMA) number printed clearly on the outside of the shipping container.

Buyers may obtain an RMA number for warranty returns by calling the SureCall Return Department toll-free at 1-888-365-6283. Any returns received by SureCall without an RMA number clearly printed on the outside of the shipping container will be returned to sender. In order to receive full credit for signal boosters, all accessories originally included in the signal booster box must be returned with the signal booster. (The Buyer does not need to include accessories sold in addition to the signal booster, such as antennas or cables.)

This warranty does not apply to any product determined by SureCall to have been subjected to misuse, abuse, neglect, or mishandling that alters or damages the product's physical or electronic properties.

SureCall warrants to the Buyer that each of its products, when shipped, will be free from defects in material and workmanship, and will perform in full accordance with applicable specifications. The limit of liability under this warranty is, at SureCall's option, to repair or replace any product or part thereof which was purchased up to THREE YEARS after May 1, 2014 or TWO YEARS for products purchased before May 1, 2014, as determined by examination by SureCall, prove defective in material and/or workmanship. Warranty returns must first be authorized in writing by SureCall. Disassembly of any SureCall product by anyone other than an authorized representative of SureCall voids this warranty in its entirety. SureCall reserves the right to make changes in any of its products without incurring any obligation to make the same changes on previously delivered products.

As a condition to the warranties provided for herein, the Buyer will prepay the shipping charges for all products returned to SureCall for repair, and SureCall will pay the return shipping with the exception of products returned from outside the United States, in which case the Buyer will pay the shipping charges.

The Buyer will pay the cost of inspecting and testing any goods returned under the warranty or otherwise, which are found to meet the applicable specifications or which are not defective or not covered by this warranty.

Products sold by SureCall shall not be considered defective or non-conforming to the Buyer's order if they satisfactorily fulfill the performance requirements that were published in the product specification literature, or in accordance with samples provided by SureCall. This warranty shall not apply to any products or parts thereof which have been subject to accident, negligence, alteration, abuse, or misuse. SureCall makes no warranty whatsoever in respect to accessories or parts not supplied by it.

Limitations of Warranty, Damages and Liability:

EXCEPT AS EXPRESSLY SET FORTH HEREIN, THERE ARE NO WARRANTIES, CONDITIONS, GUARANTEES, OR REPRESENTATIONS AS TO MERCHANTABILITY, FITNESS FOR A PARTICULAR PURPOSE, OR OTHER WARRANTIES, CONDITIONS, GUARANTEES, OR REPRESENTATIONS, WHETHER EXPRESSED OR IMPLIED, IN LAW OR IN FACT, ORAL OR IN WRITING.

SURECALL AGGREGATE LIABILITY IN DAMAGES OR OTHERWISE SHALL NOT EXCEED THE PAYMENT, IF ANY, RECEIVED BY CELLPHONE-MATE, INC. FOR THE UNIT OF PRODUCT OR SERVICE FURNISHED OR TO BE FURNISHED,

AS THE CASE MAY BE, WHICH IS THE SUBJECT OF CLAIM OR DISPUTE. IN NO EVENT SHALL SURECALL BE LIABLE FOR INCIDENTAL, CONSEQUENTIAL, OR SPECIAL DAMAGES, HOWSOEVER CAUSED.

All matters regarding this warranty shall be interpreted in accordance with the laws of the State of California, and any controversy that cannot be settled directly shall be settled by arbitration in California in accordance with the rules then prevailing of the American Arbitration Association, and judgment upon the award rendered may be entered in any court having jurisdiction thereof. If one or more provisions provided herein are held to be invalid or unenforceable under applicable law, then such provision shall be ineffective and excluded to the extent of such invalidity or unenforceability without affecting in any way the remaining provisions hereof.

Important: Changes or modifications not expressly approved by the Surecall could void the user's authority to operate the equipment.

USER CAUTION

SureCall has made a good faith effort to ensure the accuracy of the information in this document and disclaims the implied warranties of merchantability and fitness for a particular purpose and makes no express warranties, except as may be stated in its written agreement with and for its customers. SureCall shall not be held liable to anyone for any indirect, special or consequential damages due to omissions or errors. The information and specifications in this document are subject to change without notice. © 2016. All Rights Reserved. All trademarks and registered trademarks are the property of their respective owners.

Important: Before installing your booster you need to register it with your carrier. You can do so online at the following urls:

Verizon: <http://www.verizonwireless.com/wcms/consumer/register-signal-booster.html>

AT&T: <https://securec45.securewebsession.com/attsignalbooster.com/>

T-Mobile: <https://www.signalboosterregistration.com/>

Sprint: https://www.sprint.com/legal/fcc_boosters.html

U.S. Cellular: <http://www.uscellular.com/uscellular/support/fcc-booster-registration.jsp>

FCC Information:

This is a CONSUMER device.

BEFORE USE, you MUST REGISTER THIS DEVICE with your wireless provider and have your provider's consent. Most wireless providers consent to the use of signal boosters. Some providers may not consent to the use of this device on their network. If you are unsure, contact your provider.

You MUST operate this device with approved antennas and cables as specified by the manufacturer. Antennas MUST be installed at least 20 cm (8 inches) from any person. You MUST cease operating this device immediately if requested by the FCC or a licensed wireless service provider.

This device may be operated ONLY in a fixed location for in-building use.

WARNING: E911 location information may not be provided or may be inaccurate for calls served BY USING THIS DEVICE.

Note: This equipment has been tested and found to comply with the limits for a Class B digital device, pursuant to part 15 of the FCC Rules. These limits are designed to provide reasonable protection against harmful interference in a residential installation. This equipment generates, uses and can radiate radio frequency energy and, if not installed and used in accordance with the instructions, may cause harmful interference to radio communications. However, there is no guarantee that interference will not occur in a particular installation. If this equipment does cause harmful interference to radio or television reception, which can be determined by turning the equipment off and on, the user is encouraged to try to correct the interference by one or more of the following measures:

- Reorient or relocate the receiving antenna
- Increase the separation between the equipment and receiver.
- Connect the equipment into an outlet on a circuit different from that to which the receiver is connected
- Consult the dealer or an experienced radio/TV technician for help.

Industry Canada:

This Class B digital apparatus meets all requirements of the Canadian Interference Causing Equipment Regulations. Operation is subject to the following two conditions: (1) this device may not cause harmful interference, and (2) this device must accept any interference received, including interference that may cause undesired operation

Cet appareillage numérique de la classe B répond a toutes les exigences de l'interférence canadienne causant des réglemets d'équipement. L'opération est sujette aux deux conditions suivantes: (1) ce dispositif peut ne pas causer l'interférence nocive, et (2) ce dispositif doit accepter n'importe quelle interférence reçue, y compris l'interférence qui peut causer l'opération peu désirée.

The Manufacturer's rated output power of this equipment is for single carrier operation. For situations when multiple carrier signals are present, the rating would have to be reduced by 3.5 dB, especially where the output signal is re-radiated and can cause interference to adjacent band users. This power reduction is to be by means of input power or gain reduction and not by an attenuator at the output of the device.

La puissance de sortie nominale indiquée par le fabricant pour cet appareil concerne son fonctionnement avec porteuse unique. Pour des appareils avec porteuses multiples, on doit réduire la valeur nominale de 3,5 dB, surtout si le signal de sortie est retransmis et qu'il peut causer du brouillage aux utilisateurs de bandes adjacentes. Une telle réduction doit porter sur la puissance d'entrée ou sur le gain, et ne doit pas se faire au moyen d'un atténuateur raccordé à la sortie du dispositif

SureCall has made a good faith effort to ensure the accuracy of the information in this document and disclaims the implied warranties of merchantability and fitness for a particular purpose and makes no express warranties, except as may be stated in its written agreement with and for its customers. SureCall shall not be held liable to anyone for any indirect, special or consequential damages due to omissions or errors. The information and specifications in this document are subject to change without notice.

© 2017. All Rights Reserved. All trademarks and registered trademarks are the property of their respective owners.

48346 Milmont Drive
Fremont, California 94538, USA
888.365.6283
www.surecall.com

48346 Milmont Drive
Fremont, California 94538, USA
888.365.6283
www.surecall.com

This is a **CONSUMER** device.

BEFORE USE, you **MUST REGISTER THIS DEVICE** with your wireless provider and have your provider's consent. Most wireless providers consent to the use of signal boosters. Some providers may not consent to the use of this device on their network. If you are unsure, contact your provider.

You **MUST** operate this device with approved antennas and cables as specified by the manufacturer. Antennas **MUST** be installed at least 20 cm (8 inches) from any person. You **MUST** cease operating this device immediately if requested by the FCC or a licensed wireless service provider.

WARNING. E911 location information may not be provided or may be inaccurate for calls served by using this device.

This device may be operated **ONLY** in a fixed location for in-building use.