

One-door Installation Guide

Vision: 1. 0. 1 Date: Oct. 2010

1. Cautions

⚠ Please note the following cautions. Mis-operation may lead to personal injury or equipment failure:

- 1) Do not energize the system before installation is complete; never carry out installation activities when the system is energized.
- 2) All peripheral devices must be grounded.
- 3) It is preferred that all wires run through PVC or galvanized pipes.
- 4) It is strongly recommended that the length of exposed part of any connection cable should not be longer than 4 mm. Professional clamping tools may be used to avoid unintentional contact of exposed wires to avoid short-circuit or communication failure.
- 5) It is recommended that card readers and buttons should be installed at height of 1.4m-1.5m above ground.
- 6) It is recommended to use the power supply in case for control panel, and external power supply for each lock.

Description of normal working state:

Connect the system to the power supply. If the system works properly, the POWER indicator (red) is lit constantly and the RUN indicator (green) flashes.

2. Components

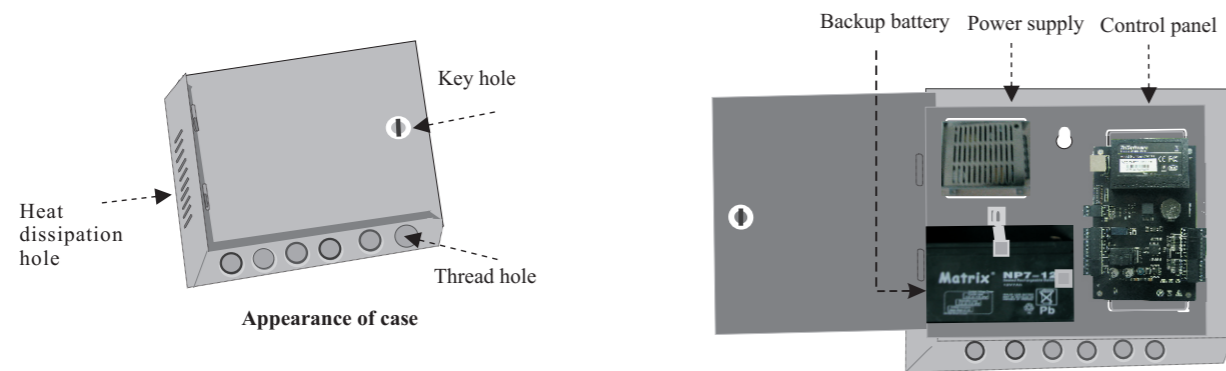

3. Get through the thread hole

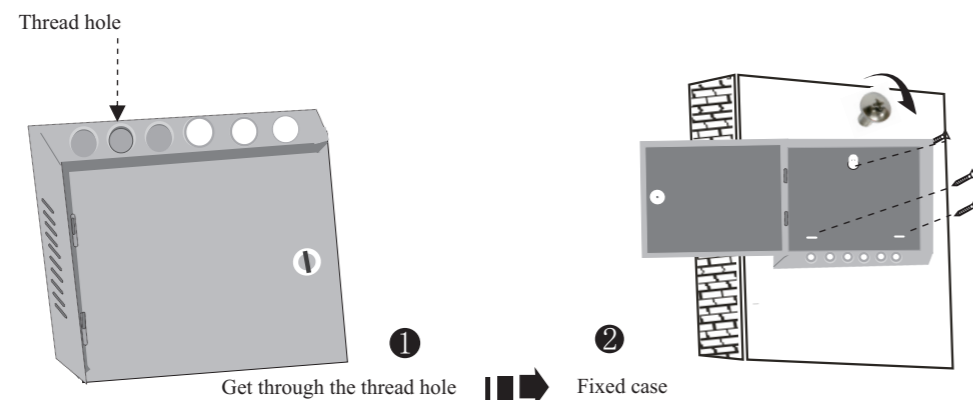

4. LED indicators, Wires, Auxiliary Input and Output

Notes:

1) Meaning of LED indicators:

LINK indicator (green): always (green) indicates TCP/IP communication is proper;

ACT indicator (yellow): its flashing indicates data is in transmitting through TCP/IP communication.

TX indicator (yellow): its flashing indicates it is sending data through RS485 communication.

RX indicator (green): its flashing indicates it is receiving data through RS485 communication.

Auxiliary output indicator (green): always (green) indicates it is in use.

Lock indicator (green): always (green) indicates lock is open.

POWER indicator (red): always (red) indicates control panel is power on.

RUN indicator (green): its flashing indicates the system works normally.

CARD indicator (yellow): its flashing indicates card is punched on reader.

2) Recommended use of wires:

A Use 2-conductor power cord

B Use 6-conductor wire between wiegand reader and control panel (RVVP 6*0.5mm) (To choose the proper cord according to the interface you connect, such as 6,8,10 cord.)

C Use 4-conductor lock power cord (RVV 4*0.75mm)

D Use 2-conductor switch power cord (RVV 2*0.5mm)

3) The auxiliary input may be connected to infrared body detectors, alarm switches, etc.

4) The auxiliary output may be connected to door bells, alarms, etc.

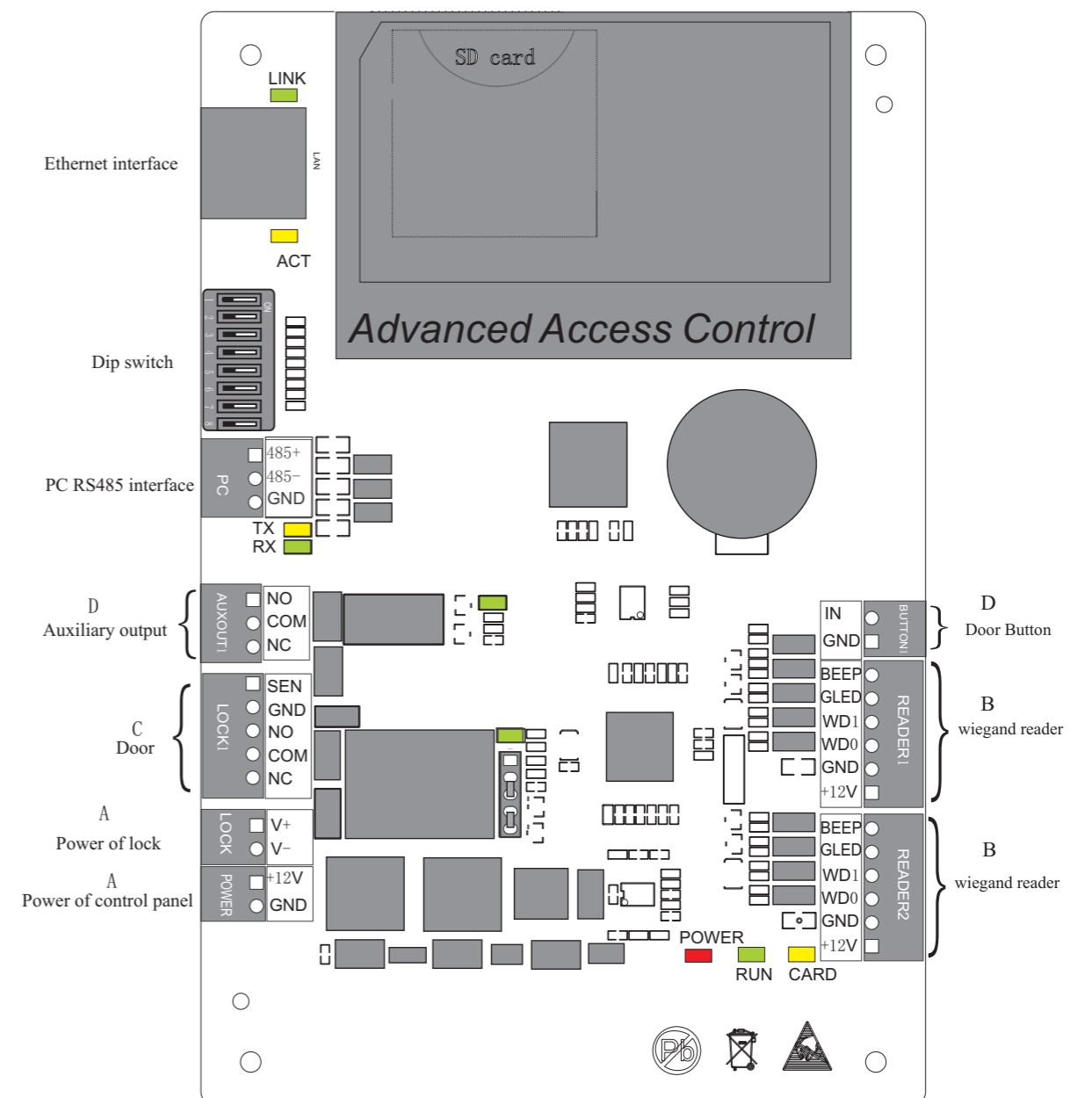

5. RS485 address setting, Restore factory setting, Terminal resistance setting

Set RS485 address through DIP switch:

- 1) Place 1-6 on DIP switch are for setting the number of control panel when communicating through RS485, it is adopted for binary coding, and little endian, the address represented by place 1-6 are shown as figure(5-1).
- 2) Before setting the address, please keep the system is power off, Jump place 1-6 to desired status, and the address number shall not be the same as another one in the network. For example: to set the device number as 39 ($39=1+2+4+32$), the corresponding RS485 code is 111001, then Jump place 1,2,3 and 6 at "ON" status.

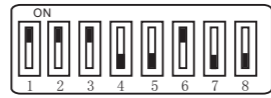

- 3) Place 7 is for restoring factory default settings, Jump it for three times within 10 seconds and restart the system, then all information in RAM of control panel will be cleared and the system restores factory default settings.
- 4) Place 8 is for setting terminal resistance when communicating through RS485. Jump it at "ON" status, then it is equivalent to have a terminal resistance of 120 ohm between 485+ and 485-.

Diagram of places of DIP switch.

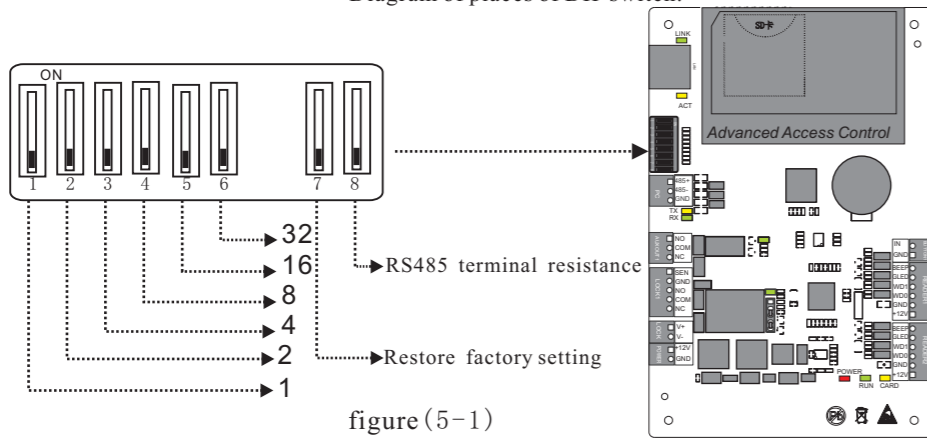
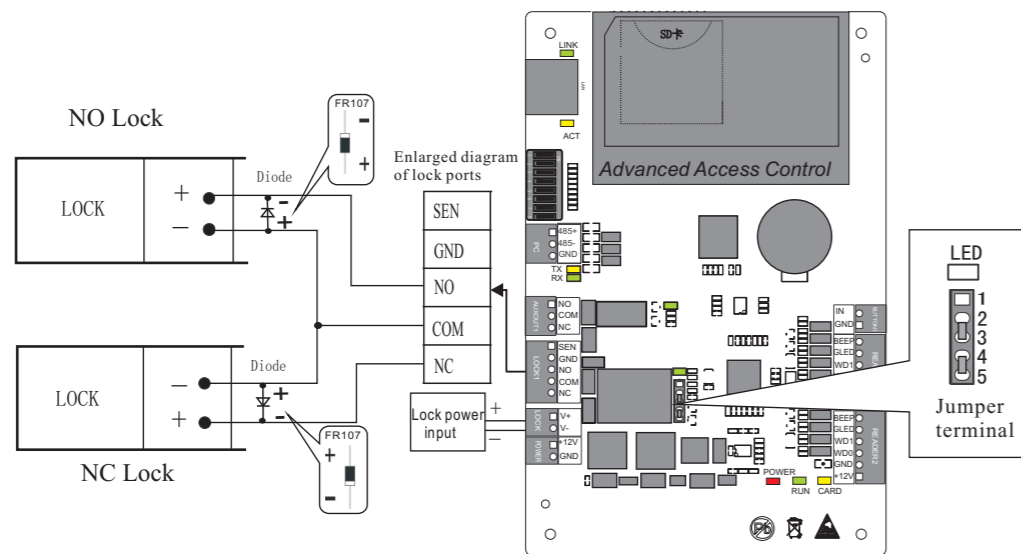

figure (5-1)

6. Connection of lock

- 1) Control panel provides lock control output interfaces. For NO lock, it is open when power is on, and closed when power is off, so COM and NO interfaces should be used; For NC lock, it is open when power is off, and closed when power is on, so COM and NC interfaces should be used.
- 2) Control panel supports "dry mode" and "wet mode" by setting the jumper, it is "wet mode" when connecting "V+ V-" Input interfaces to supply power for locks, please shorten 2-3 and 4-5. Equipment factory default setting is dry mode. For setting "dry mode" and "wet mode", please refer to <<C3-100/200/400 access control panel installation instructions>>.
- 3) When the Electrical Lock is connected to the Access Control System, you need to parallel one FR107 diode (equipped in the package) to prevent the self-inductance EMF affecting the system, do not reverse the polarities.



"Wet mode" wiring diagram of lock connecting with external power supply.

7. Equipment communication

- ⚠ The background PC software is able to communicate with the system according to two protocols(RS485 and TCP/IP) for data exchange and remote management. The communication cable should be away from high-voltage lines as far as possible. Do not keep the communication cable in parallel with power cords or bind them together.

1. TCP/IP Communication

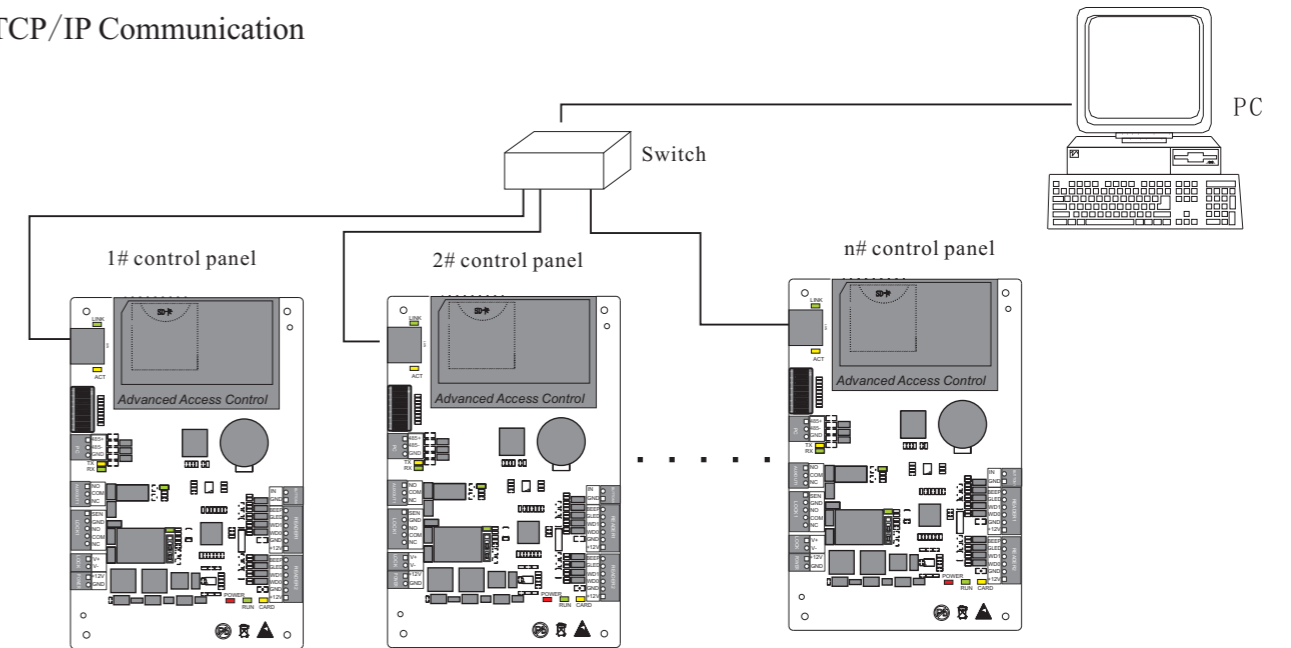

2. RS485 Communication

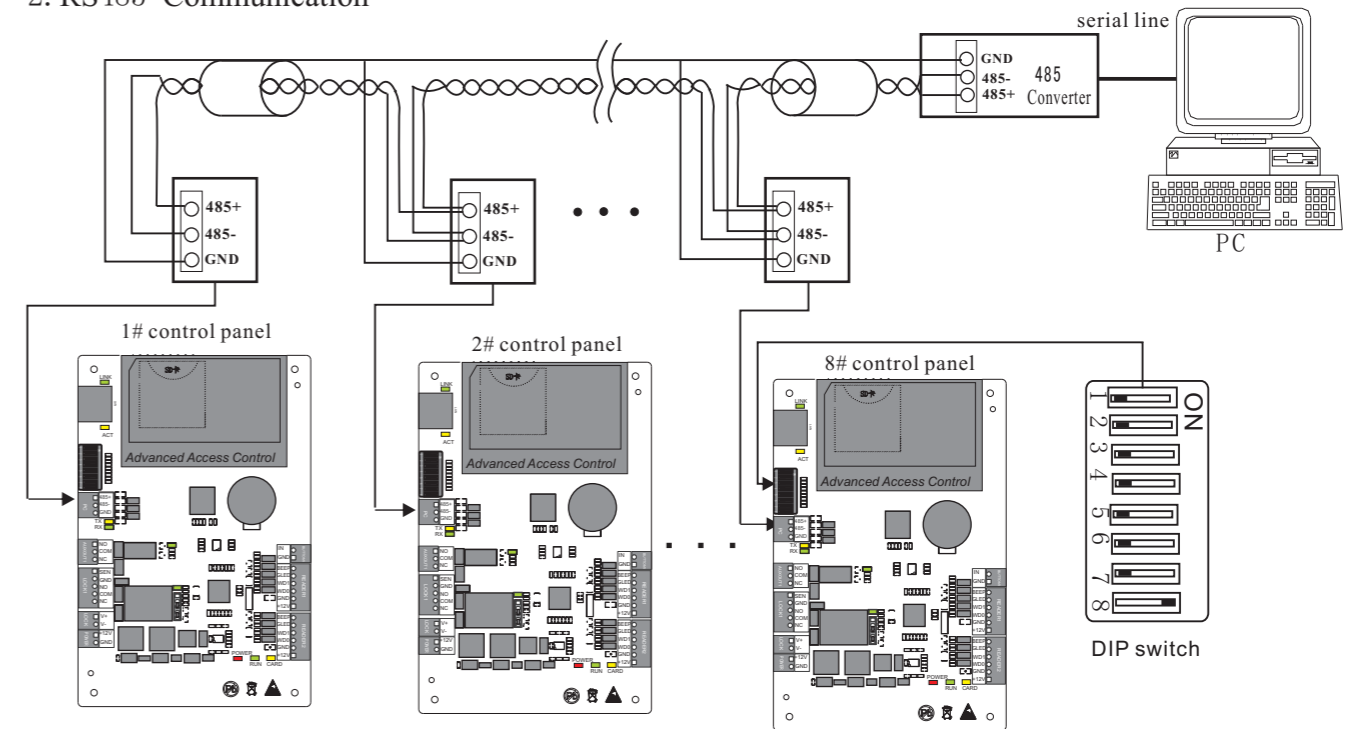

Notes:

- 1) Internationally accepted RVSP(shielded twisted-pair) wires should be used for communication to effectively avoid interference. RS485 communication wires should be connected by means of bus cascade connection.
- 2) Considering stability of communication, it is recommended the length of RS485 bus is less than 600m
- 3) One RS485 BUS may hold 63 units of control panel, but it is not recommended to connect with more than 32 units access control panels..
- 4) When the bus is longer than 300m, to enhance the stability of communication, it is necessary to keep place 8 of DIP switches of the first and the last control panel at "ON" status. As shown in the figure above, place 8 of the DIP switches of units 1# and 8# is placed at "ON" status.

